

22 512 892



- sporgenza 135 mm
- bocca girevole 360°
- Getto circolare con aria
- altezza rubinetteria 275 mm
- altezza fino al rompigitto 168 mm
- diametro foro 35 mm
- rosetta Ø 59 mm
- 2x tubo flessibile di mandata M 10 x 1 avvitato, tenuta controllata
- portata max 7 l/min
- senza piombo
- Questo prodotto può aiutare un edificio a soddisfare i requisiti dei Green Building Rating Systems, ad es. LEED®, BREEAM®, DGNB

Solamente per lavabo con troppopieno.

	Platinato spazzolato	22 512 892-06
	Cromato	22 512 892-00
	Platinato	22 512 892-08
	Dark Chrome	22 512 892-19
	Ottone spazzolato (Oro 23k)	22 512 892-28
	Nero opaco	22 512 892-33
	Champagne spazzolato (Oro 22k)	22 512 892-46
	Champagne (Oro 22k)	22 512 892-47
	Cromo spazzolato	22 512 892-93
	Dark Platinum spazzolato	22 512 892-99

22 512 892

mm [inches]



Diagramma di portata



Certificati

ETA_18512.

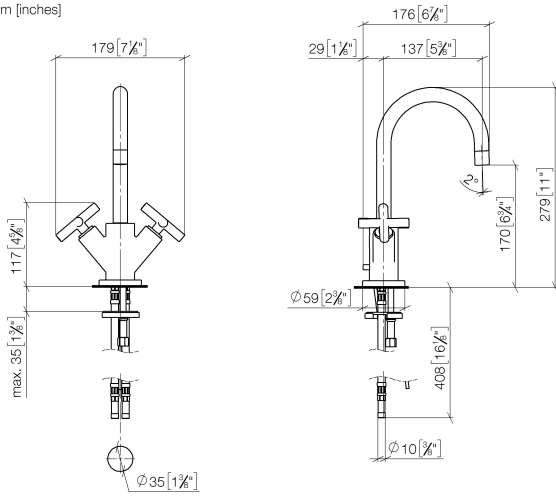
WRAS_1810003.

LGA_18920.

GDV_0400194.

22 512 892

Parts for other finishes can be found here: Cromato

